

NO. OF CONTACTS	A	B MAX	C**
2	.10	.185	.300
3	.20	.285	.400
4	.30	.385	.500
5	.40	.485	.600
6	.50	.585	.700
7	.60	.685	.800
8	.70	.785	.900
9	.80	.885	1.000
10	.90	.985	1.100
11	1.00	1.085	1.200
12	1.10	1.185	1.300
13	1.20	1.285	1.400

NO. OF CONTACTS	A	B MAX	C**
14	1.30	1.385	1.500
15	1.40	1.485	1.600
16	1.50	1.585	1.700
17	1.60	1.685	1.800
18	1.70	1.785	1.900
19	1.80	1.885	2.000
20	1.90	1.985	2.100

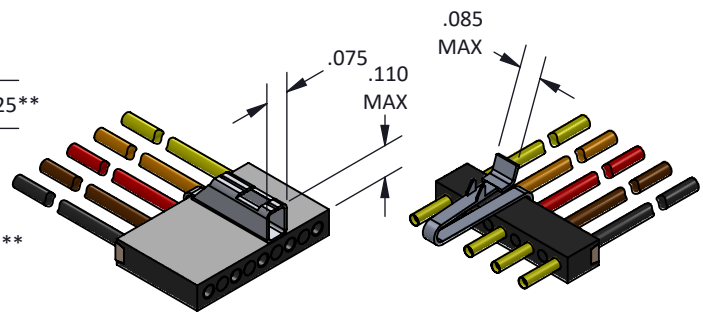
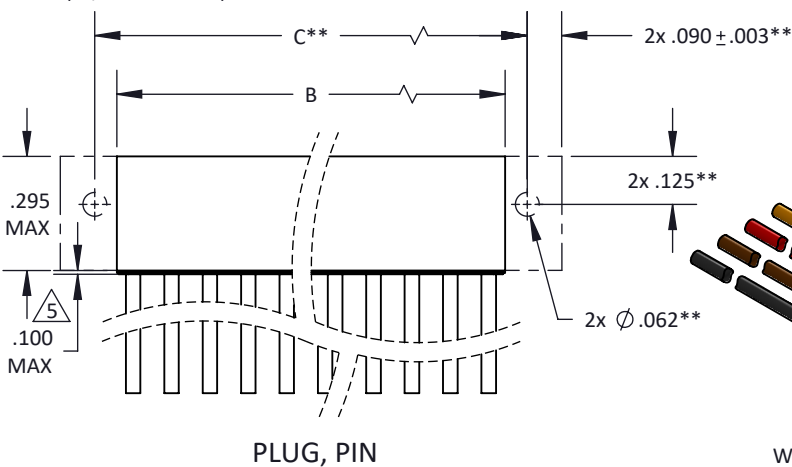
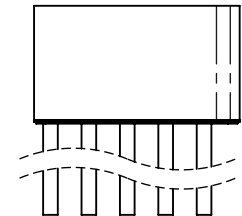
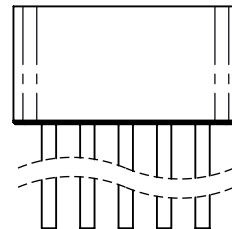
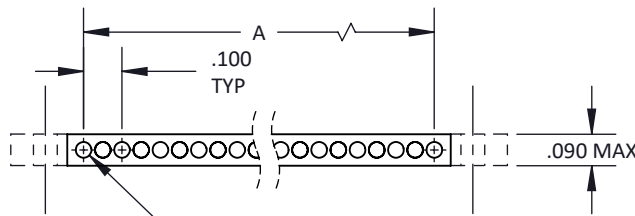
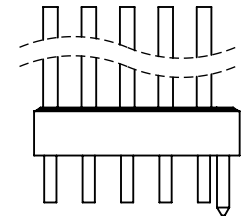
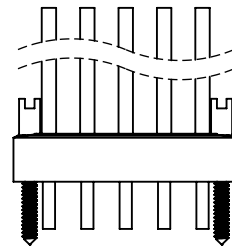
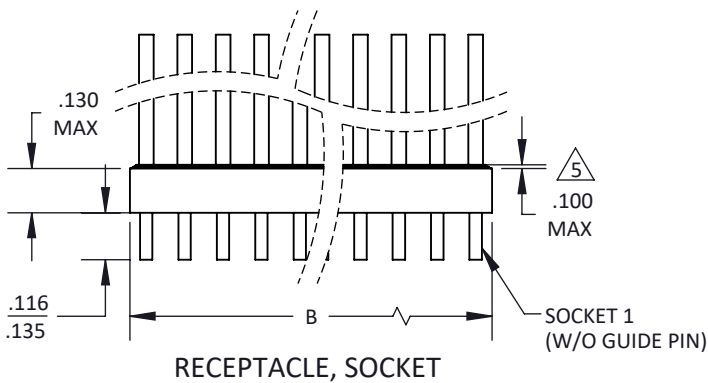

TOLERANCE: .XXX ±.005
.XX ±.01
ANGLE ±1°

TITLE
CENTI-STRIP
(.100 SPACING MICRO STRIP)

SHT 1 OF 2

DWG. NO.

CCS

REV
H

THINGS TO KNOW ABOUT MICRO STRIPS

- FOR ORDERING PURPOSES SPECIFY ONLY THE NUMBER OF CONTACTS NEEDED, DO NOT INCLUDE POSITIONS FOR HARDWARE.
- IF HARDWARE IS ORDERED, EXCEPT FOR LATCHES IT IS INSTALLED IN THE RECEPTACLE. BE SURE TO ORDER PLUGS TO ACCEPT HARDWARE.
- HARDWARE CAN BE MODIFIED, COMBINED OR POSITIONED TO CONFORM TO CUSTOMER SPECIFICATIONS. PLEASE CONTACT CRISTEK FOR FURTHER INFORMATION.

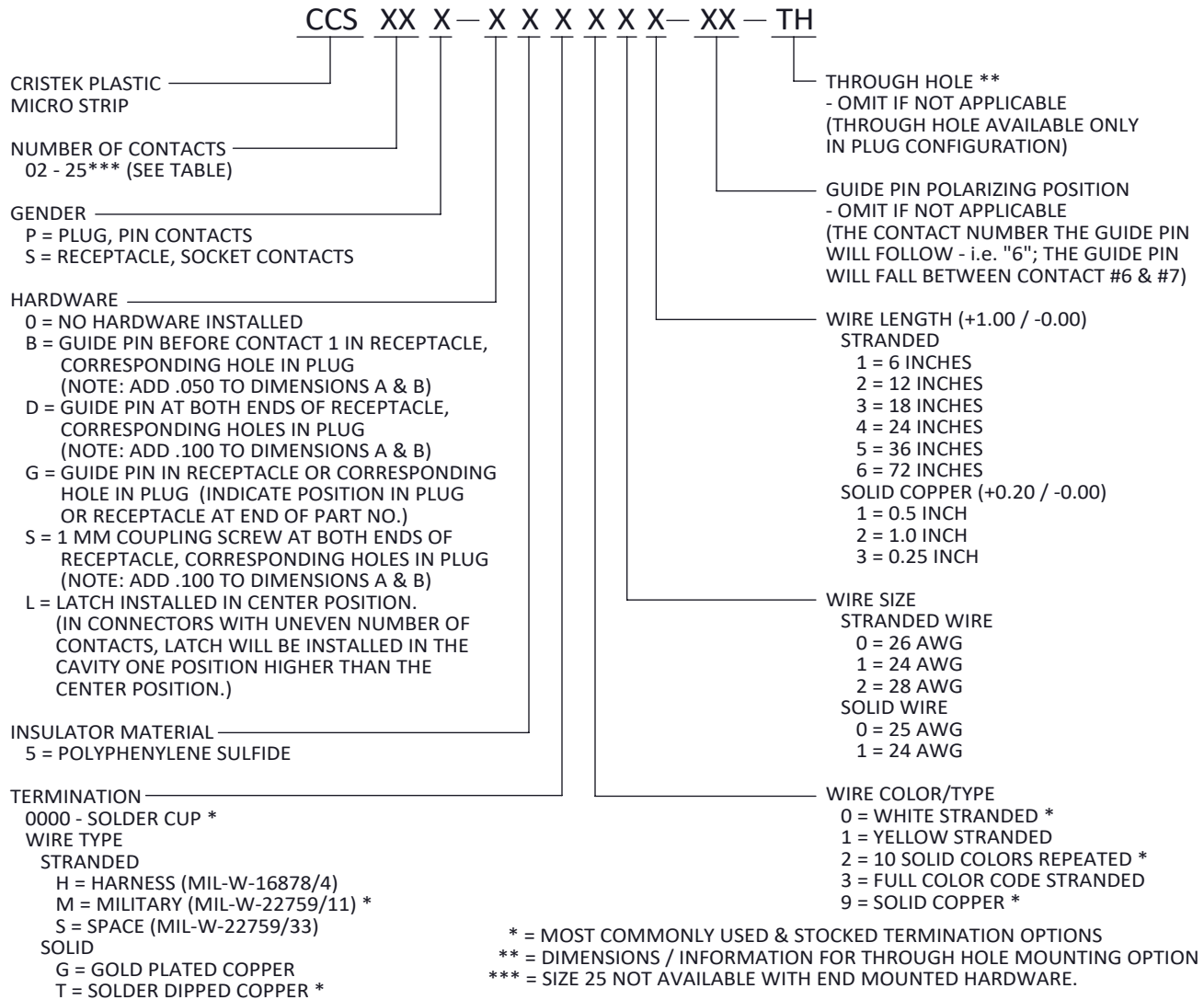

MATERIALS AND FINISHES ARE IAW MIL-DTL-83513 FOR DETAILS SEE MIL SPEC OR WWW.CRISTEK.COM

- | | | |
|--|---|--|
| <p>1. MATERIALS:
INSULATOR - GLASS FILLED THERMOPLASTIC
PIN/SOCKET CONTACT - COPPER ALLOY</p> <p>2. FINISH:
CONTACT - GOLD OVER NICKEL</p> | <p>3. SPECIFICATIONS:
CURRENT RATING ----- 3 AMPS MAX
TEMPERATURE RATING ----- -55° C TO +125° C
INSULATION RESISTANCE ----- 5000 MEGOHMS MIN
DWV AT SEA LEVEL ----- 600 VAC
DWV AT 70,000 FT ALTITUDE --- 150 VAC
CONTACT RESISTANCE ----- 8 MILLIOHMS MAX AT 2.5 AMPS
LOW LEVEL CONTACT ----- 10 MILLIOHMS MAX
RESISTANCE
CONTACT RETENTION ----- 5 lb MINIMUM AXIAL LOAD
ENGAGEMENT FORCE ----- 6 oz MAX
SEPARATION FORCE ----- 0.5 oz MIN</p> | <p>4. ADDITIONAL INFORMATION:
CONTACT CRISTEK FOR OTHER CONFIGURATIONS.</p> <p> STANDARD HEIGHT OF EPOXY. SOME SIZES AND APPLICATIONS MAY REQUIRE ADDITIONAL STRAIN RELIEF. CONTACT CRISTEK FOR DETAILS.</p> |
|--|---|--|

TOLERANCE: .XXX ±.005 .XX ±.01 ANGLE ±1°	TITLE CENTI-STRIP (.100 SPACING MICRO STRIP)	SHT 2 OF 2	DWG. NO. CCS	REV H
--	--	------------	-----------------	-----------------