

BASIC SHELL DIMENSIONS

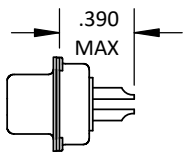

SOLDER CUP

2X SPACERS
(MILITARY ONLY)

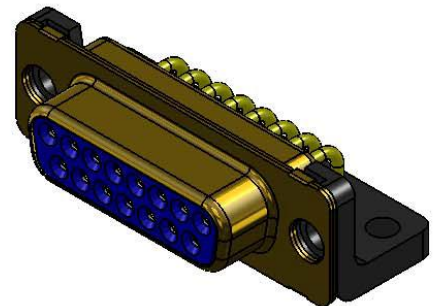
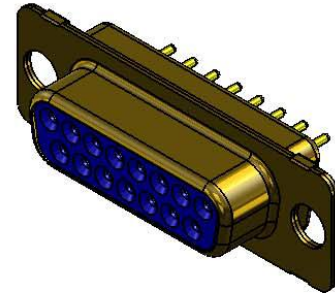
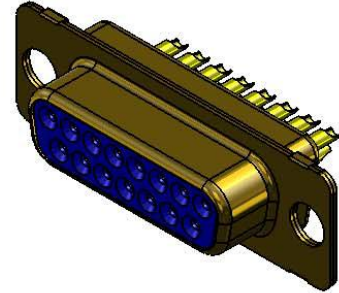
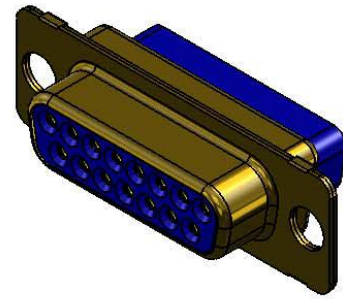
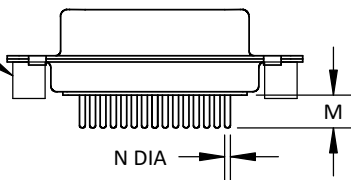

STRAIGHT P.C.B. MOUNT

SEE SHT 3 FOR
P.C.B. HOLE PATTERNS

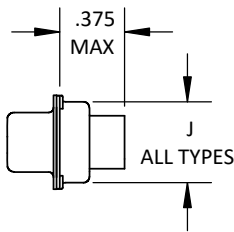

CRIMP CONTACTS

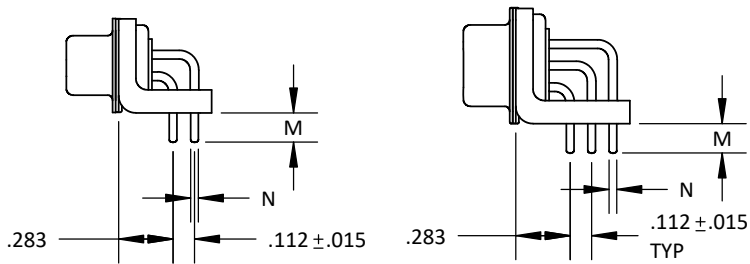

RIGHT ANGLE P.C.B. MOUNT

SEE SHT 3 FOR
P.C.B. HOLE PATTERNS

TOLERANCE: .XXX ±.005
.XX ±.01
ANGLE ±1°

TITLE

D-SUBMINIATURE

SHT 1 OF 6

DWG. NO.

M24308

REV

H

PART NO. OF SHELL SIZE	A ±.015	B** .666 .643	C ±.005 .984	D** .329 .311	E ±.015 .494	F .422 .429	G .234 .243	H ±.010 .759	J ±.010 .422	K .070 .030	L .040 .020
DEG9P DEG9S	1.213	.666 .643	.984	.329 .311	.494	.422 .429	.234 .243	.759	.422	.070 .030	.040 .020
DAG15P DAG15S	1.541	.994 .971	1.312	.329 .311	.494	.422 .429	.234 .243	1.083	.422	.070 .030	.040 .020
DBG25P DBG25S	2.088	1.534 1.511	1.852	.329 .311	.494	.426 .429	.230 .243	1.625	.422	.070 .030	.039 .030
DCG37P DCG37S	2.729	2.182 2.159	2.500	.329 .311	.494	.426 .429	.230 .243	2.272	.422	.070 .030	.039 .030
DDG50P DDG50S	2.635	2.079 2.064	2.406	.441 .423	.605	.426 .429	.230 .243	2.178	.534	.070 .030	.039 .030

G = DIALLYL PHTHALATE WITH METAL CLIPS (CRIMP STYLE ONLY)

** B & D DIMENSIONS APPLY TO THE O.D. OF THE RECEPTACLE/SOCKET AND THE I.D. OF THE PLUG/PIN.

P.C.B. STYLE CONTACT TAILS AVAILABLE			
CONTACT STYLE	M	N _{DIA}	CRISTEK TERMINATION "SUFFIX"
STRAIGHT	.185/.130	.030	3B
STRAIGHT	.210/.155	.030	3E
STRAIGHT	.185/.130	.040	3D
STRAIGHT	.210/.155	.040	3C
90° RIGHT ANGLE	.154/.099	.030	5G
90° RIGHT ANGLE	.185/.130	.030	5J
90° RIGHT ANGLE	.154/.099	.040	5F
90° RIGHT ANGLE	.185/.130	.040	5H
90° RIGHT ANGLE	.210/.155	.030	5L
90° RIGHT ANGLE	.210/.155	.040	5K

FOR APPLICABLE PART NUMBERS
SEE CROSS REFERENCE CHART

MATERIALS AND FINISHES ARE IAW MIL-DTL-24308
FOR DETAILS SEE MIL SPEC OR WWW.CRISTEK.COM

1. MATERIALS:

SHELL - STEEL
INSULATOR - DIALLYL PHTHALATE TYPE SDG-F
CONTACT - COPPER ALLOY
SPACER - BRASS ALLOY

2. FINISH:

SHELL AND SPACER - CADMIUM WITH YELLOW CHROMATE
CONVERSION COATING
CONTACT - GOLD OVER NICKEL

3. SPECIFICATIONS:

CURRENT RATING ----- 7.5 AMPS MAX
TEMPERATURE RATING ----- -55° C TO +125° C
INSULATION RESISTANCE ----- 5000 MEGOHMS
DWV AT SEA LEVEL ----- 1000 VAC
DWV AT 70,000 FT ALTITUDE --- 325 VAC
CONTACT RETENTION ----- 9 LBS AXIAL LOAD
ENGAGEMENT FORCE ----- 18 oz MAX
SEPARATION FORCE ----- 0.7 oz MIN

4. ADDITIONAL INFORMATION:

FOR CROSS-REFERENCING CRISTEK
PART NUMBERS TO M24308, SEE
CROSS REFERENCE INFORMATION
AT THE FRONT OF THIS SECTION.
FOR MOUNTING HARDWARE
OPTIONS, SEE THE HARDWARE
PAGES AT THE END OF THIS SECTION.

TOLERANCE: .XXX ±.005 .XX ±.01 ANGLE ±1°	TITLE D-SUBMINIATURE	SHT 2 OF 6	DWG. NO. M24308	REV H
--	--------------------------------	--------------------------	---------------------------	-----------------

SOCKET INSERT MATING FACE (RECEPTACLE)

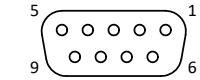

SHELL SIZE 1, 9 SOCKET CONTACT SIZE #20

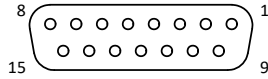

SHELL SIZE 2, 15 SOCKET CONTACT SIZE #20

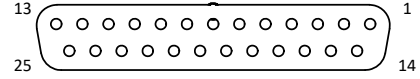

SHELL SIZE 3, 25 SOCKET CONTACT SIZE #20

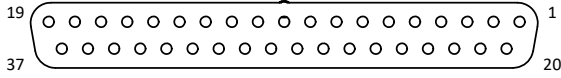

SHELL SIZE 4, 37 SOCKET CONTACT SIZE #20

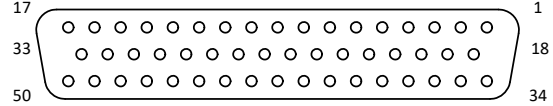

SHELL SIZE 5, 50 SOCKET CONTACT SIZE #20

PIN INSERT MATING FACE (PLUG)

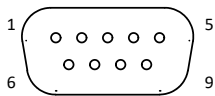

SHELL SIZE 1, 9 PIN CONTACT SIZE #20

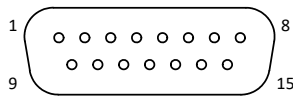

SHELL SIZE 2, 15 PIN CONTACT SIZE #20

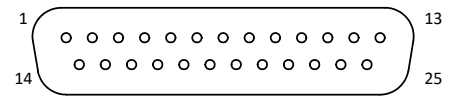

SHELL SIZE 3, 25 PIN CONTACT SIZE #20

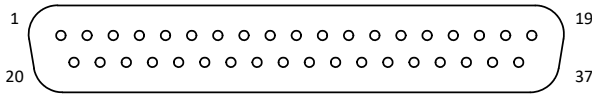

SHELL SIZE 4, 37 PIN CONTACT SIZE #20

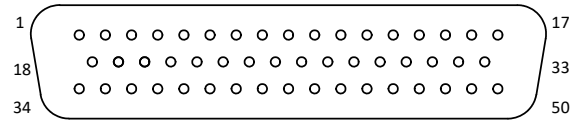

SHELL SIZE 5, 50 PIN CONTACT SIZE #20

P.C.B. HOLE PATTERNS (LAYOUTS FOR STRAIGHT AND 90° CONFIGURATIONS)

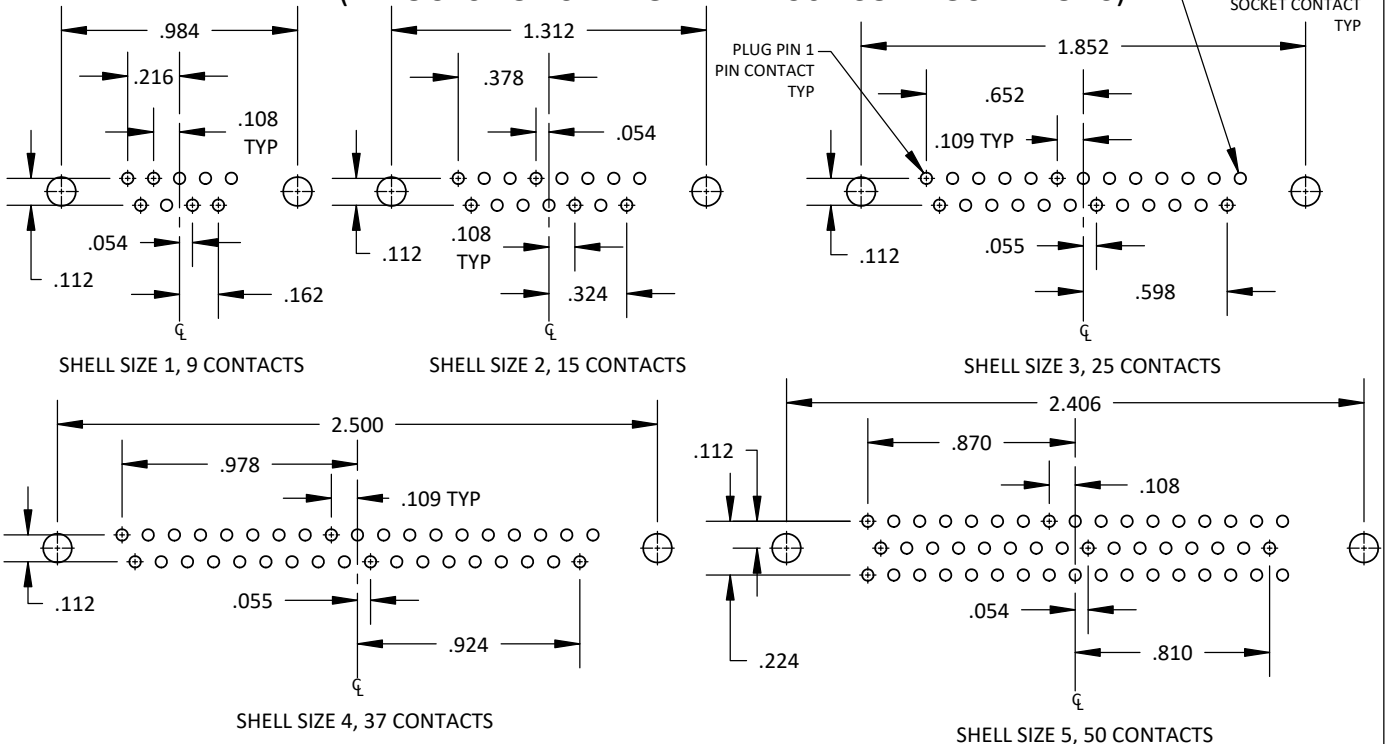

TOLERANCE: .XXX ±.005
.XX ±.01
ANGLE ±1°

TITLE

D-SUBMINIATURE

SHT 3 OF 6

DWG. NO.

M24308

REV

H

MILITARY PART NUMBER	CRISTEK PART NUMBER	DESCRIPTION	MILITARY PART NUMBER	CRISTEK PART NUMBER	DESCRIPTION
M24308/1-1F M24308/1-2F M24308/1-3F M24308/1-4F M24308/1-5F	DEG9S2-P6 DAG15S2-P6 DBG25S2-P6 DCG37S2-P6 DDG50S2-P6	Receptacle, Socket Solder Contacts	M24308/3-1F M24308/3-2F M24308/3-3F M24308/3-4F M24308/3-5F	DEG9P2-P6 DAG15P2-P6 DBG25P2-P6 DCG37P2-P6 DDG50P2-P6	Plug, Pin Solder Contacts
M24308/1-23F M24308/1-24F M24308/1-25F M24308/1-26F M24308/1-27F	DEG9S2D-P6 DAG15S2D-P6 DBG25S2D-P6 DCG37S2D-P6 DDG50S2D-P6	Receptacle, Socket Solder Contacts Dual Float Mount	M24308/3-17F M24308/3-18F M24308/3-19F M24308/3-20F M24308/3-21F	DEG9P2D-P6 DAG15P2D-P6 DBG25P2D-P6 DCG37P2D-P6 DDG50P2D-P6	Plug, Pin Solder Contacts Dual Float Mount
M24308/2-1F M24308/2-2F M24308/2-3F M24308/2-4F M24308/2-5F	DEG9S1-P6 DAG15S1-P6 DBG25S1-P6 DCG37S1-P6 DDG50S1-P6	Receptacle, Socket Crimp Contacts	M24308/4-1F M24308/4-2F M24308/4-3F M24308/4-4F M24308/4-5F	DEG9P1-P6 DAG15P1-P6 DBG25P1-P6 DCG37P1-P6 DDG50P1-P6	Plug, Pin Crimp Contacts
M24308/2-6F M24308/2-7F M24308/2-8F M24308/2-9F M24308/2-10F	DEG9S1-T2-P6 DAG15S1-T2-P6 DBG25S1-T2-P6 DCG37S1-T2-P6 DDG50S1-T2-P6	Kit Receptacle, Socket Crimp Contacts With I/R Tool	M24308/4-6F M24308/4-7F M24308/4-8F M24308/4-9F M24308/4-10F	DEG9P1-T2-P6 DAG15P1-T2-P6 DBG25P1-T2-P6 DCG37P1-T2-P6 DDG50P1-T2-P6	Kit Plug, Pin Crimp Contacts with I/R Tool
M24308/2-281F M24308/2-282F M24308/2-283F M24308/2-284F M24308/2-285F	DEG9S1NO-P6 DAG15S1NO-P6 DBG25S1NO-P6 DCG37S1NO-P6 DDG50S1NO-P6	Receptacle, Less Socket Crimp Contacts	M24308/4-259F M24308/4-260F M24308/4-261F M24308/4-262F M24308/4-263F	DEG9P1NO-P6 DAG15P1NO-P6 DBG25P1NO-P6 DCG37P1NO-P6 DDG50P1NO-P6	Plug, Less Pin Crimp Contacts
M24308/2-342F M24308/2-343F M24308/2-344F M24308/2-345F M24308/2-346F	DEG9S1D-P6 DAG15S1D-P6 DBG25S1D-P6 DCG37S1D-P6 DDG50S1D-P6	Receptacle, Socket Crimp Contacts Dual Float Mount	M24308/4-435F M24308/4-436F M24308/4-437F M24308/4-438F M24308/4-439F	DEG9P1D-P6 DAG15P1D-P6 DBG25P1D-P6 DCG37P1D-P6 DDG50P1D-P6	Plug, Pin Crimp Contacts Dual Float Mount
M24308/2-353F M24308/2-354F M24308/2-355F M24308/2-356F M24308/2-357F	DEG9S1D-T2-P6 DAG15S1D-T2-P6 DBG25S1D-T2-P6 DCG37S1D-T2-P6 DDG50S1D-T2-P6	Kit Receptacle, socket Crimp Contacts, Dual Float Mount with I/R Tool	M24308/4-446F M24308/4-447F M24308/4-448F M24308/4-449F M24308/4-450F	DEG9P1D-T2-P6 DAG15P1D-T2-P6 DBG25P1D-T2-P6 DCG37P1D-T2-P6 DDG50P1D-T2-P6	Kit Plug, Pin Crimp Contacts Dual Float Mount with I/R Tool
M24308/2-482F M24308/2-483F M24308/2-484F M24308/2-485F M24308/2-486F	DEG9S1DNO-P6 DAG15S1DNO-P6 DBG25S1DNO-P6 DCG37S1DNO-P6 DDG50S1DNO-P6	Receptacle, Less Socket Crimp Contacts, Dual Float Mount	M24308/4-457F M24308/4-458F M24308/4-459F M24308/4-460F M24308/4-461F	DEG9P1DNO-P6 DAG15PD1NO-P6 DBG25P1DNO-P6 DCG37P1DNO-P6 DDG50P1DNO-P6	Plug, Less Pin Crimp Contacts Dual Float Mount

M24308 TO CRISTEK PART NUMBER CROSS REFERENCE

TOLERANCE: .XXX ±.005 .XX ±.01 ANGLE ±1°	TITLE D-SUBMINIATURE	SHT 4 OF 6	DWG. NO. M24308	REV H
--	-------------------------	------------	--------------------	----------

MILITARY PART NUMBER	CRISTEK PART NUMBER	DESCRIPTION	MILITARY PART NUMBER	CRISTEK PART NUMBER	DESCRIPTION
M24308/23-1F M24308/23-2F M24308/23-3F M24308/23-4F M24308/23-5F	DEG9S3B-P6 DAG15S3B-P6 DBG25S3B-P6 DCG37S3B-P6 DDG50S3B-P6	Receptacle, Socket Straight P.C. Tail- .030 Diameter- .185/.130 Long	M24308/24-1F M24308/24-2F M24308/24-3F M24308/24-4F M24308/24-5F	DEG9P3B-P6 DAG15P3B-P6 DBG25P3B-P6 DCG37P3B-P6 DDG50P3B-P6	Plug, Pin Straight P.C. Tail- .030 Diameter- .185/.130 Long
M24308/23-7F M24308/23-8F M24308/23-9F M24308/23-10F M24308/23-11F	DEG9S3E-P6 DAG15S3E-P6 DBG25S3E-P6 DCG37S3E-P6 DDG50S3E-P6	Receptacle, Socket Straight P.C. Tail- .030 Diameter- .210/.155 Long	M24308/24-7F M24308/24-8F M24308/24-9F M24308/24-10F M24308/24-11F	DEG9P3E-P6 DAG15P3E-P6 DBG25P3E-P6 DCG37P3E-P6 DDG50P3E-P6	Plug, Pin Straight P.C. Tail- .030 Diameter- .210/.155 Long
M24308/23-13F M24308/23-14F M24308/23-15F M24308/23-16F M24308/23-17F	DEG9S3D-P6 DAG15S3D-P6 DBG25S3D-P6 DCG37S3D-P6 DDG50S3D-P6	Receptacle, Socket Straight P.C. Tail- .040 Diameter- .185/.130 Long	M24308/24-13F M24308/24-14F M24308/24-15F M24308/24-16F M24308/24-17F	DEG9P3D-P6 DAG15P3D-P6 DBG25P3D-P6 DCG37P3D-P6 DDG50P3D-P6	Plug, Pin Straight P.C. Tail- .040 Diameter- .185/.130 Long
M24308/23-19F M24308/23-20F M24308/23-21F M24308/23-22F M24308/23-23F	DEG9S3C-P6 DAG15S3C-P6 DBG25S3C-P6 DCG37S3C-P6 DDG50S3C-P6	Receptacle, Socket Straight P.C. Tail- .040 Diameter- .210/.155 Long	M24308/24-19F M24308/24-20F M24308/24-21F M24308/24-22F M24308/24-23F	DEG9P3C-P6 DAG15P3C-P6 DBG25P3C-P6 DCG37P3C-P6 DDG50P3C-P6	Plug, Pin Straight P.C. Tail- .040 Diameter- .210/.155 Long
M24308/23-25F M24308/23-26F M24308/23-27F M24308/23-28F M24308/23-29F	DEG9S5G-P6 DAG15S5G-P6 DBG25S5G-P6 DCG37S5G-P6 DDG50S5G-P6	Receptacle, Socket 90° P.C. Tail- .030 Diameter- .154/.099 Long	M24308/24-25F M24308/24-26F M24308/24-27F M24308/24-28F M24308/24-29F	DEG9P5G-P6 DAG15P5G-P6 DBG25P5G-P6 DCG37P5G-P6 DDG50P5G-P6	Plug, Pin 90° P.C. Tail- .030 Diameter- .154/.099 Long
M24308/23-31F M24308/23-32F M24308/23-33F M24308/23-34F M24308/23-35F	DEG9S5J-P6 DAG15S5J-P6 DBG25S5J-P6 DCG37S5J-P6 DDG50S5J-P6	Receptacle, Socket 90° P.C. Tail- .030 Diameter- .185/.130 Long	M24308/24-31F M24308/24-32F M24308/24-33F M24308/24-34F M24308/24-35F	DEG9P5J-P6 DAG15P5J-P6 DBG25P5J-P6 DCG37P5J-P6 DDG50P5J-P6	Plug, Pin 90° P.C. Tail- .030 Diameter- .185/.130 Long
M24308/23-37F M24308/23-38F M24308/23-39F M24308/23-40F M24308/23-41F	DEG9S5F-P6 DAG15S5F-P6 DBG25S5F-P6 DCG37S5F-P6 DDG50S5F-P6	Receptacle, Socket 90° P.C. Tail- .040 Diameter- .154/.099 Long	M24308/24-37F M24308/24-38F M24308/24-39F M24308/24-40F M24308/24-41F	DEG9P5F-P6 DAG15P5F-P6 DBG25P5F-P6 DCG37P5F-P6 DDG50P5F-P6	Plug, Pin 90° P.C. Tail- .040 Diameter- .154/.099 Long
M24308/23-43F M24308/23-44F M24308/23-45F M24308/23-46F M24308/23-47F	DEG9S5H-P6 DAG15S5H-P6 DBG25S5H-P6 DCG37S5H-P6 DDG50S5H-P6	Receptacle, Socket 90° P.C. Tail- .040 Diameter- .185/.130 Long	M24308/24-43F M24308/24-44F M24308/24-45F M24308/24-46F M24308/24-47F	DEG9P5H-P6 DAG15P5H-P6 DBG25P5H-P6 DCG37P5H-P6 DDG50P5H-P6	Plug, Pin 90° P.C. Tail- .040 Diameter- .185/.130 Long
M24308/23-49F M24308/23-50F M24308/23-51F M24308/23-52F M24308/23-53F	DEG9S5L-P6 DAG15S5L-P6 DBG25S5L-P6 DCG37S5L-P6 DDG50S5L-P6	Receptacle, Socket 90° P.C. Tail- .030 Diameter- .210/.155 Long	M24308/24-49F M24308/24-50F M24308/24-51F M24308/24-52F M24308/24-53F	DEG9P5L-P6 DAG15P5L-P6 DBG25P5L-P6 DCG37P5L-P6 DDG50P5L-P6	Plug, Pin 90° P.C. Tail- .030 Diameter- .210/.155 Long
M24308/23-55F M24308/23-56F M24308/23-57F M24308/23-58F M24308/23-59F	DEG9S5K-P6 DAG15S5K-P6 DBG25S5K-P6 DCG37S5K-P6 DDG50S5K-P6	Receptacle, Socket 90° P.C. Tail- .040 Diameter- .210/.155 Long	M24308/24-55F M24308/24-56F M24308/24-57F M24308/24-58F M24308/24-59F	DEG9P5K-P6 DAG15P5K-P6 DBG25P5K-P6 DCG37P5K-P6 DDG50P5K-P6	Plug, Pin 90° P.C. Tail- .040 Diameter- .210/.155 Long

G = DIALYLPHTHALATE WITH METAL CLIPS (CRIMP STYLE ONLY)

NOTE : THE CROSS REF ABOVE REPRESENTS THE MIL-SPEC PARTS ONLY. MANY OTHER OPTIONS AND CUSTOM MODIFICATIONS ARE AVAILABLE. PLEASE CONTACT FACTORY.

M24308 TO CRISTEK PART NUMBER CROSS REFERENCE

TOLERANCE: .XXX ±.005 .XX ±.01 ANGLE ±1°	TITLE D-SUBMINIATURE	SHT 5 OF 6	DWG. NO. M24308	REV H
--	--------------------------------	------------	---------------------------	-----------------

MILITARY PART NUMBER	CRISTEK PART NUMBER	DESCRIPTION	MILITARY PART NUMBER	CRISTEK PART NUMBER	DESCRIPTION
M24308/5-1F M24308/5-2F M24308/5-3F M24308/5-4F M24308/5-5F	DEG9S2B-P6 DAG15S2B-P6 DBG25S2B-P6 DCG37S2B-P6 DDG50S2B-P6	Receptacle, Socket Solder Contacts	M24308/7-1F M24308/7-2F M24308/7-3F M24308/7-4F M24308/7-5F	DEG9P2B-P6 DAG15P2B-P6 DBG25P2B-P6 DCG37P2B-P6 DDG50P2B-P6	Plug, Pin Solder Contacts
M24308/6-1F M24308/6-2F M24308/6-3F M24308/6-4F M24308/6-5F	DEG9S1B-P6 DAG15S1B-P6 DBG25S1B-P6 DCG37S1B-P6 DDG50S1B-P6	Receptacle, Socket Crimp Contacts	M24308/8-1F M24308/8-2F M24308/8-3F M24308/8-4F M24308/8-5F	DEG9P1B-P6 DAG15P1B-P6 DBG25P1B-P6 DCG37P1B-P6 DDG50P1B-P6	Plug, Pin Crimp Contacts
M24308/6-281F M24308/6-282F M24308/6-283F M24308/6-284F M24308/6-285F	DEG9S1BNO-P6 DAG15S1BNO-P6 DBG25S1BNO-P6 DCG37S1BNO-P6 DDG50S1BNO-P6	Receptacle, Less Socket Crimp Contacts	M24308/8-259F M24308/8-260F M24308/8-261F M24308/8-262F M24308/8-263F	DEG9P1BNO-P6 DAG15P1BNO-P6 DBG25P1BNO-P6 DCG37P1BNO-P6 DDG50P1BNO-P6	Plug, Less Pin Crimp Contacts

NOTE : THE CROSS REF ABOVE REPRESENTS ONLY THE BRASS-SHELLED VERSION OF THE MIL-SPEC PART. MANY OTHER OPTIONS AND CUSTOM MODIFICATIONS ARE AVAILABLE. PLEASE CONTACT FACTORY.

G = DIALLYL PHTHALATE WITH METAL CLIPS (CRIMP STYLE ONLY)

M24308 TO CRISTEK PART NUMBER CROSS REFERENCE FOR NON-MAGNETIC D-SUB CONNECTORS

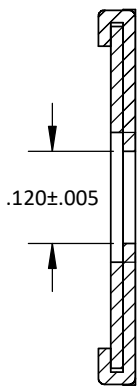

STANDARD THROUGH-HOLE

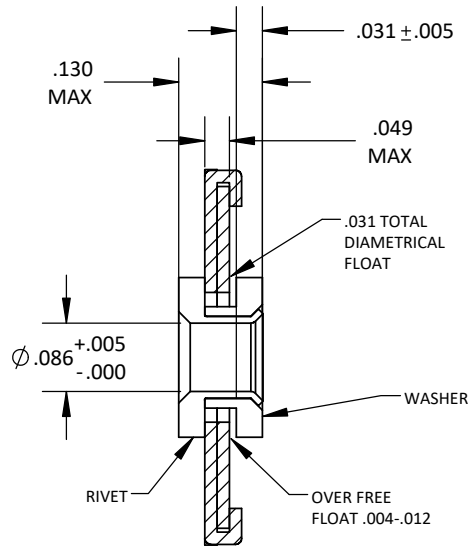

DUAL FLOAT MOUNT

TOLERANCE: .XXX ±.005 .XX ±.01 ANGLE ±1°	TITLE D-SUBMINIATURE	SHT 6 OF 6	DWG. NO. M24308	REV H
--	--------------------------------	------------	---------------------------	-----------------